

| | |
|---------------|--|
| Project Name: | |
| Type: | |

WMU Series

LED Emergency Light
Wireless Reporting Compatible

TECHNICAL SPECIFICATION

| | |
|----------------------|--|
| Rated Power Supply | : 220 - 24VAC 50/60Hz |
| Charge Time | : 24 hours |
| Discharge duration | : 1 hour and 3 hours option |
| Battery | : Ni-cad battery 7.2V 2000mAh |
| Lumen output | : 1H: 700lm, 3H: 400lm |
| Chageover voltage | : 144 - 187VAC |
| Test facility | : Manual test/ AUTO test / LynxEM® wireless testing and reporting system available |
| Operation | : Non-Maintained |
| Mounting | : Wall mount |
| LED | : SMD 2835, CCT 5000K, CRI>70 |
| Degree of protection | : IP65 |
| Insulation Class | : Class II |
| Housing material | : Polycarbonate |
| Ambient temperature | : 0°C...+45°C |
| Certification | : CE |



WARRANTY

- See [Limited Warranty Policy](#) for more additional information

RELATED PRODUCTS

[WCU Series](#)

[WSU Series](#)

[S1 Series](#)

[S3 Series](#)

CE  IP65

PRODUCT DIMENSION

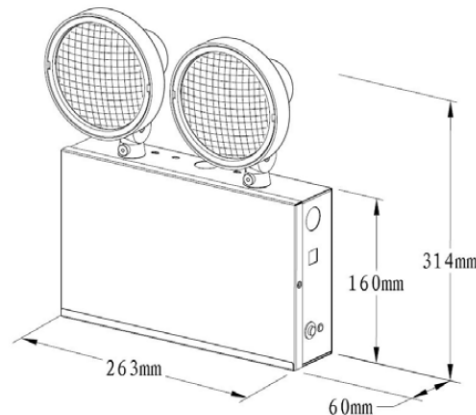

ORDER INFORMATION: EXAMPLE: WMU-ZD-WH

| | | |
|------------------------------|---|----------------------|
| WMU | - | - |
| MODEL | OPTION | HOUSING COLOR |
| WMU Waterproof EM | MT Manual test CT Self-testing/ Self-Diagnostics ZD Wireless Reporting LynxEM® Control | WH White |

| | |
|---------------|--|
| Project Name: | |
| Type: | |

WMU Series

LED Emergency Light
Wireless Reporting Compatible

Compliant Europe standard EN1838

Illuminance requirement: Escape route up to 2m wide, 1lx on the central axis and 0.5 lx at 50% of the width

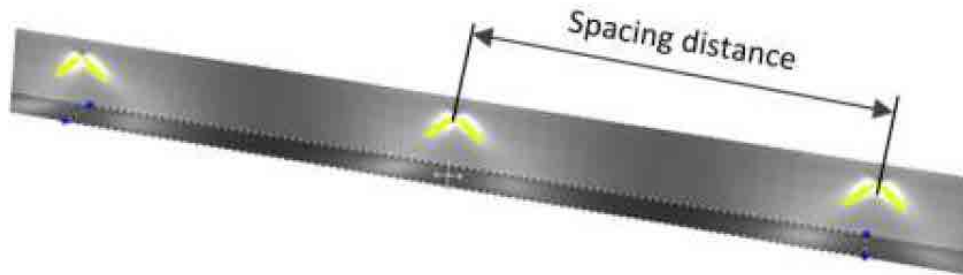
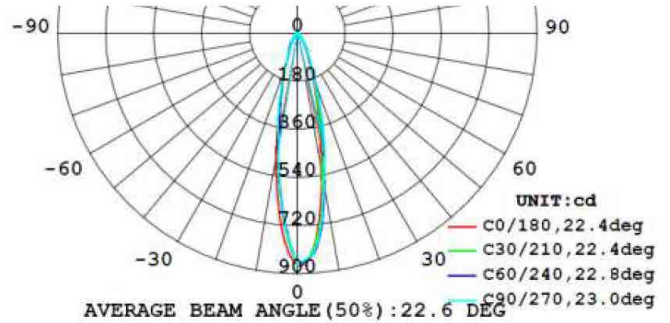

WMU/ 1H 700lm output

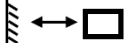
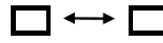
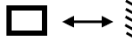
| Mounting Height |  |  |  | Average illuminance on 1m wide route | Min. illuminance on 1m wide route |
|-----------------|---|---|---|--------------------------------------|-----------------------------------|
| 2.5m | 10.0m | 25m | 10.0m | 10lx | 1.2lx |
| 3.0m | 10.5m | 27m | 10.5m | 8.0lx | 1.2lx |
| 3.5m | 12.0m | 30m | 12.0m | 6.5 lx | 1.1lx |
| 4.0m | 12.5m | 32m | 12.5m | 5.5 lx | 1.1lx |

WMU/ 3H 400lm output

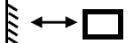
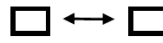
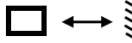
| Mounting Height |  |  |  | Average illuminance on 1m wide route | Min. illuminance on 1m wide route |
|-----------------|---|---|---|--------------------------------------|-----------------------------------|
| 2.5m | 9.0m | 23m | 9.0m | 6.0lx | 1.0lx |
| 3.0m | 9.5m | 24m | 9.5m | 5.2lx | 1.2lx |
| 3.5m | 9.5m | 24m | 9.5m | 6.5 lx | 1.2lx |
| 4.0m | 10.0m | 25m | 10.0m | 4.0 lx | 1.1lx |